

# HUNTLEIGH

## D900/D920/D930

Anwendungshinweise

Kullanım Talimatları

Brugsvejledning

Instrucciones de uso

χρήσης

使用方

Mode d'emploi

Bruksanvisning

Gebruiksaanwijzing

aanwijzing

# INSTRUCTIONS FOR USE

Bruksan

talimatları

使用方法

Käyttöohjeet

Instruções de Utilização

Istruzioni per l'uso

Anwendungshinweise

Οδηγίες χρήσης

Anwendungshinweise

## HIGH SENSITIVITY POCKET DOPPLERS

# Table of Contents

## Doppler Measurement Sites and Recommended Probes ..... 3

1. Safety .....	4
<b>1.1 Warnings</b> .....	<b>4</b>
<b>1.2 Patient Applied Parts</b> .....	<b>5</b>
<b>1.3 Acoustic Safety</b> .....	<b>5</b>
2. Introduction .....	7
<b>2.1 Unpacking / Preliminary Checks</b> .....	<b>7</b>
<b>2.2 Battery Insertion / Replacement</b> .....	<b>7</b>
<b>2.3 Product Controls</b> .....	<b>8</b>
<b>2.4 Product Labelling</b> .....	<b>9</b>
3. Operation .....	10
<b>3.1 Vascular Mode (D900 Only)</b> .....	<b>10</b>
<b>3.2 Obstetric Mode</b> .....	<b>11</b>
<b>3.3 After Use</b> .....	<b>12</b>
4. Care and Cleaning .....	13
<b>4.1 General Care</b> .....	<b>13</b>
<b>4.2 General Cleaning and Disinfecting</b> .....	<b>14</b>
<b>4.3 Cleaning and Disinfecting Patient Applied Parts</b> .....	<b>14</b>
<b>4.4 Maintenance and Repair</b> .....	<b>15</b>
5. Specifications .....	16
<b>5.1 Equipment Classification</b> .....	<b>16</b>
<b>5.2 Standards Compliance</b> .....	<b>16</b>
<b>5.3 General</b> .....	<b>17</b>
<b>5.4 Environmental</b> .....	<b>17</b>
6. End of Life Disposal.....	18
7. Warranty .....	19
8. Service.....	21

# Doppler Measurement Sites and Recommended Probes

1 Jugular Vein  
VP4HS, VP5HS

2 Subclavian Vein  
VP4HS, VP5HS

3 Fetus  
OP2HS, OP3HS

4 Femoral Vein  
VP4HS, VP5HS

5 Great Saphenous Vein  
VP5HS, VP8HS, EZ8

6 Small Saphenous Vein  
VP8HS, EZ8

7 Posterior Tibial Vein  
VP8HS, VP10HS, EZ8

8 Posterior Tibial Artery  
VP8HS, EZ8

9 Vertebral Artery  
VP4HS, VP5HS

10 Carotid Artery  
VP5HS, VP8HS, EZ8

11 Subclavian Artery  
VP4HS, VP5HS

12 Brachial Artery  
VP8HS, EZ8

13 Ulnar Artery  
VP8HS, EZ8

14 Radial Artery  
VP8HS, EZ8

15 Femoral Artery  
VP4HS, VP5HS

16 Digital Artery  
VP8HS, VP10HS, EZ8

17 Penis  
VP10HS, EZ8

18 Popliteal Artery  
VP5HS

19 Metatarsal Artery  
VP8HS, VP10HS, EZ8

20 Dorsalis Pedis Artery  
VP8HS, VP10HS, EZ8

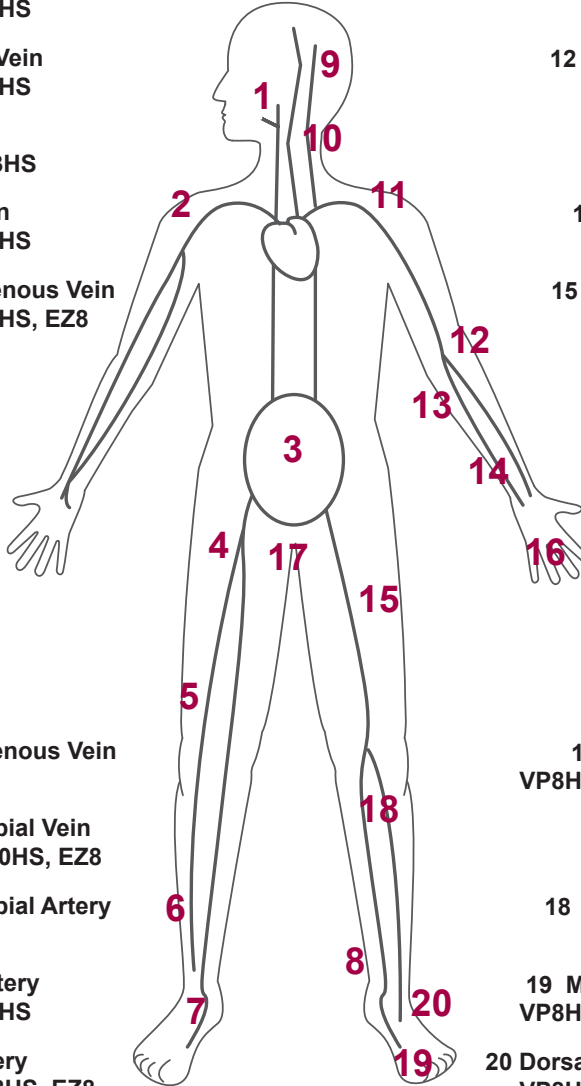

# 1. Safety



Before using this equipment, please study this manual carefully and familiarize yourself with the controls, display features and operation. Ensure that each user fully understands the safety and operation of the unit, as mis-use may cause harm to the user or patient, or damage to the product.



We recommend that exposure to ultrasound should be kept As Low As Reasonably Achievable - (ALARA guidelines). This is considered to be good practice and should be observed at all times.



Federal law restricts this device to sale by or on the order of a licensed practitioner

***Please keep these Instructions for Use to hand for future reference.***

---



Attention, consult this manual. Refer to safety section.

---



Attention, consult accompanying documents / Instructions for Use

---

## 1.1 Warnings

---



***Do not use in the presence of flammable gases such as anaesthetic agents***

---



***Do not use in the sterile field unless additional barrier precautions are taken.***

---



***Do Not :***

- ***immerse in any liquid, (except D920/D930 probe)***
  - ***use solvent cleaner,***
  - ***use high temperature sterilizing processes (such as autoclaving),***
  - ***use E-beam or gamma radiation sterilization.***
- 



***The main unit is not waterproof and must not be immersed. For underwater use where contamination or cross-infection may occur, additional barrier precautions must be taken.***

---



***Do not use on the eye or scrotum.***



***Do not dispose of batteries in fire as this can cause them to explode.***



***Do not attempt to recharge normal dry-cell batteries. They may leak, cause a fire or even explode.***



***This product contains sensitive electronics, therefore, strong radio frequency fields could possibly interfere with it. This will be indicated by unusual sounds from the loudspeaker. We recommend that the source of interference is identified and eliminated***



***Any equipment connected to the waveform output socket must be compliant with IEC60601-1:2005.***



***Connect headphones only to the headphone socket.***



***Dopplex Dopplers are screening tools to aid the healthcare professional and should not be used in place of normal vascular or fetal monitoring. If there is doubt as to vascularity or fetal well-being after using the unit, further investigations should be undertaken immediately using alternative techniques.***

## 1.2 Patient Applied Parts

As defined in IEC60601-1:2005, the patient applied parts of the Dopplex Dopplers are the ultrasound probes.

## 1.3 Acoustic Safety

Continuous wave Doppler ultrasound instruments such as the D900, D920 & D930 have been used extensively for medical diagnosis in the United States for over 25 years. Throughout this period, there have been no reports of adverse effects to patients or instrument operators at the acoustic intensities recommended for diagnostic use. Despite this highly favorable safety experience, available data are not conclusive and the possibility remains that unwanted biological effects might be identified in the future. Authorities therefore recommend that ultrasound procedures be performed in accordance with the "ALARA" principle, which states that the energy delivered to the patient should always be kept As Low As Reasonably Achievable. With the D900, D920 & D930, the transmitted acoustic power is fixed and cannot be adjusted by the operator. Therefore, the user can best observe the ALARA principle by ensuring that each examination is medically indicated and by limiting the duration of the study to the extent appropriate for the clinical objectives.

Acoustic intensity data ( $I_{SPTA,3}$ ) for probes available for use with the D900, D920 & D930 are summarized in the following table. The values cited are based on measurements in water using a calibrated hydrophone and are stated as the estimated derated intensities. The derated intensity constitutes the most biologically relevant parameter available since true determinations of actual absorbed dose in tissue would require invasive measurement techniques. The derated intensity is therefore calculated mathematically using a derating factor consisting of a constant (the assumed attenuation coefficient) and allowing for the frequency of the probe and the distance from the probe face to the hydrophone.

The calculated derated intensity values for the D900, D920 & D930 compare very favorably with previously reported acoustic safety data for Doppler ultrasound instruments and are appropriate for all clinical applications recommended in this manual. As the operating mode of the Doppler range of probes is continuous wave,  $I_{SPPA}$  figures are not applicable.

Acoustic Output Table, Track1, Non-Auto-Scanning Mode						
Model	Max Value $I_{SPTA,3}$	Wo	$f_c$	$Z_{sp}$	A-6, ( $Z_{sp}$ )	EBD
OP2HS	55	41	2.0	2.5	1.1	1.2 x 2.5
OP3HS	55	32	3.0	2.0	1.2	1.2 x 2.5
VP4HS	92	7.5	4.0	0.8	0.14	0.365 x 0.8
VP5HS	92	8.2	5.0	0.8	0.12	0.365 x 0.8
VP8HS	92	4.0	8.0	0.48	0.026	0.215 x 0.5
EZ8	92	14.3	8.0	0.67	0.064	0.635 x 0.22
VP10HS	92	1.4	10.0	0.48	0.022	0.215 x 0.5

## NOTES

- Measurement uncertainty: varies with probe and measurement  
 Random - typically  $\pm 20\%$  (max.  $\pm 32\%$ )  
 Systematic - typically  $\pm 6.5\%$  (max.  $\pm 8\%$ )







## Definition of Terms

- $I_{SPTA,3}$  is the derated spatial-peak, temporal-average intensity (milliwatts per square centimeter)
- Wo** is the ultrasonic power (milliwatts)
- $f_c$  is the center frequency (MegaHertz)
- $Z_{sp}$  is the axial distance used to calculate the derated intensity (centimeters)
- A-6 ( $Z_{sp}$ )** is  $(\pi / 4) \times (X-6 \times Y-6)$  where X-6, Y-6 are respectively the in-plane (azimuthal) and out-of-plane (elevational) -6dB dimensions in the X-Y plane where  $Z_{sp}$  is found (centimeters)
- EBD** are the entrance beam dimensions for the azimuthal and elevational planes (centimeters)

## 2. Introduction

### 2.1 Unpacking / Preliminary Checks

#### Contents

		D900 Only 
		

#### Delivery Inspection

Huntleigh takes every precaution to ensure that goods reach you in perfect condition. However, accidental damage can occur in transit and storage. For this reason we recommend that a thorough visual inspection is made immediately the unit is received. Should any damage be evident or any parts missing, ensure that Huntleigh or your distributor is informed at once.

#### Storage

Should the unit not be required for immediate use, it should be re-sealed into its original packing after carrying out the initial delivery inspection, and stored under covered conditions at a temperature between +14°F to +104°F (-10°C to +40°C), and relative humidity of 10% to 93% non-condensing.

### 2.2 Battery Insertion / Replacement

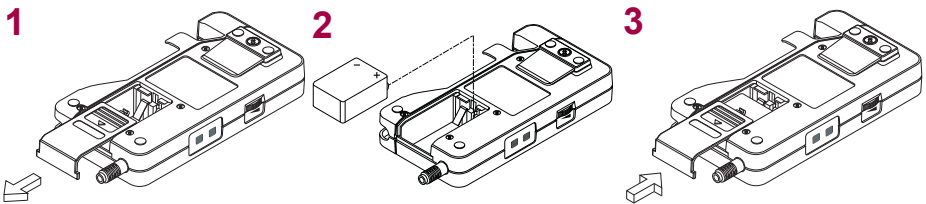

**Note:** Remove the battery if the unit is not likely to be used for some time.



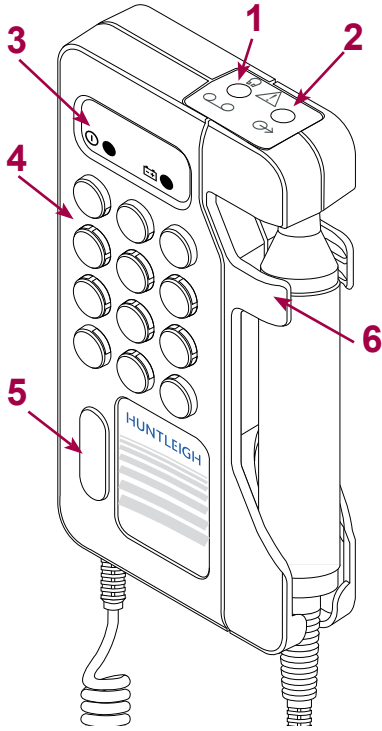



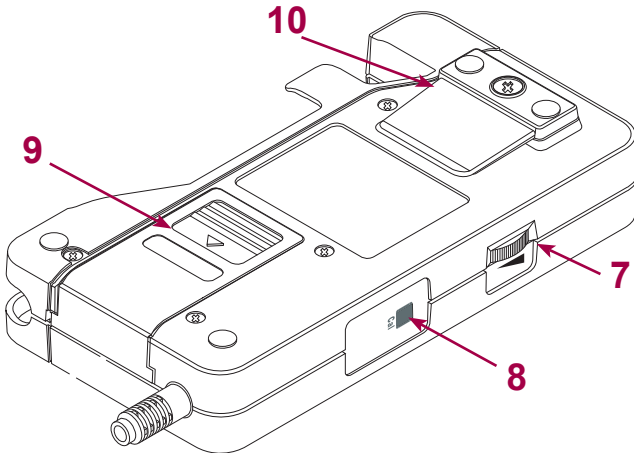











## 2.3 Product Controls



	D900	D920 D930	
1	•	•	Headphone Socket
2	•		Waveform Socket
3	•	•	LED Panel
4	•	•	Loud-speaker
5	•	•	On/Off Button
6	•	•	Probe Holder
7	•	•	Volume Control
8	•		Cal Button
9	•	•	Battery Compartment
10	•	•	Pocket Clip



## 2.4 Product Labelling

	Applied parts (ultrasound probes are type B according to the definitions in IEC60601-1:1988)		
	Power On/Off		Battery
	This symbol signifies that this product, including its accessories and consumables is subject to the WEEE (Waste Electrical and Electronic Equipment) regulations and should be disposed of responsibly in accordance with local procedures.		
	Attention, consult this manual. Refer to safety section.		
	Attention, consult accompanying documents / Instructions for Use		
	This symbol signifies that this product complies with the essential requirements of the Medical Devices Directive 93/42/EEC as amended by 2007/47/EC		
<b>Rx only</b>	Caution: Federal law restricts this device to sale by or on the order of a licensed practitioner.		
	Alignment mark		Waveform Output Socket
	Volume		Headphone Socket
	Temperature Limitations	"MAX 93% RH"	Limits of Relative Humidity
	Serial Number		Reference Number
	Keep Dry		Do not use hook
	Fragile		Cardboard packaging can be recycled.

## 3. Operation



**Refer to diagram on page 3 for Doppler Measuring sites and Recommended Probes.**

To connect the probe, align the arrow on the connector with the slot on the probe and push firmly.

To disconnect the probe, pull the connector sharply. DO NOT pull the cable.

Note: During use, an automatic noise reduction feature operates on low level signals to improve sound quality.

### LED Indicators

Green LED - indicates power ON

Yellow LED - flashes when battery is low

### Coupling Gel

Use water based ultrasound gel ONLY.

### 3.1 Vascular Mode (D900 Only)

The D900 will select vascular mode when a vascular probe is connected to the control unit.

#### Vascular Probes

Five probes are available for vascular examinations:

<b>VP4HS</b>	<b>4MHz <math>\pm</math>1% for deep lying vessels</b>
<b>VP5HS</b>	<b>5MHz <math>\pm</math>1% for deep lying vessels and oedematous limbs</b>
<b>VP8HS</b>	<b>8MHz <math>\pm</math>1% for peripheral vessels</b>
<b>VP10HS</b>	<b>10MHz <math>\pm</math>1% for specialist superficial applications.</b>
<b>EZ8</b>	<b>8MHZ <math>\pm</math>1% "Widebeam" for peripheral vessels.</b>

## Clinical Use

Apply a liberal amount of gel on the site to be examined. Place the probe at 45° to the skin surface over the vessel to be examined. Adjust the position of the probe to obtain the loudest audio signal. High pitched pulsatile sounds are emitted from arteries while veins emit a non-pulsatile sound similar to a rushing wind.

For best results, keep the probe as still as possible once the optimum position has been found. Adjust the audio volume as required.

## Waveform Recording - D900 Only

The D900 can be connected to a chart recorder by using a suitable lead that plugs into the Waveform socket. (For more information on the chart recorder, refer to the manufacturer's handbook).

## Cal Function

The baseline and sensitivity of the chart recorder can be set up using the Cal function. This generates a zero velocity baseline and a sequence of pulses as shown below:

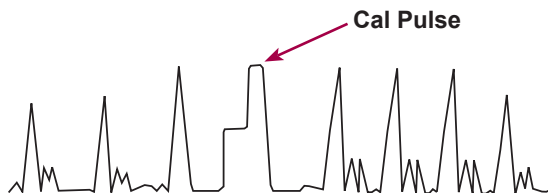

Two levels of calibration pulses are provided. While Cal is active, calibration tones synchronized to the calibration pulses are superimposed on the audio signal.

If the button is pressed and held, then the calibration sequence is repeated. When the calibration sequence is complete, normal operation is resumed.

## 3.2 Obstetric Mode

### D900 only

Obstetric mode is automatically selected when an obstetric probe (OP2HS/OP3HS) is connected to the control unit.

In this mode the waveform output and Cal function are disabled.

## Obstetric Probes

Two probes are available for obstetric examinations:

<b>OP2HS</b>	<b>2MHz ±1%</b>
<b>OP3HS</b>	<b>3MHz ±1%</b>

### Audio / Flexi Dopplex (D920/D930)

Both the Audio Dopplex and the Flexi Dopplex have fixed waterproof probes (IPX7) for underwater use.



***The D920/D930 main unit is not waterproof and must not be immersed.***

---

### Clinical Use

Apply a liberal amount of gel to the abdomen\*. Place the faceplate of the probe flat against the abdomen above the symphysis pubis. Adjust the probe to obtain an optimum audio signal ideally by angling the probe around. Avoid sliding it over the skin.

In early pregnancy a full bladder may improve sound detection. In later pregnancy the best signals are generally located higher on the abdomen. The fetal heart sounds like a galloping horse at approximately twice the maternal rate. A wind-like sound is heard from the placenta.

The Dopplex units can detect fetal heart sounds from as early as 9 to 10 weeks gestation.

*Note that early detection (9-12 weeks) is highly dependent on operator skill and other factors and may not always be possible.*

*\*Note: For D920/D930 : Gel is not required when probe is used underwater.*

### 3.3 After Use

1. Press and release the On/Off button. If you forget to switch the unit off, it will automatically shut-off after 5 minutes.
2. Refer to the cleaning section before storing or using the unit on another patient.
3. Store unit together with probe and accessories in the soft carry case provided.

## 4. Care and Cleaning

### 4.1 General Care

All Huntleigh products have been designed to withstand normal clinical use, however they can contain delicate components, for example the probe tip, which should be handled and treated with care.

Periodically, and whenever the integrity of the system is in doubt, carry out a check of all functions as described in the relevant section of the IFU. If there are any defects to the housing contact Huntleigh or your distributor for repair or to order a replacement.



***Please ensure that you check with your facility's local infection control policy and medical equipment cleaning procedures.***



***Observe warnings and guidance on cleaning fluid labelling regarding use and personal protective equipment (PPE).***



***Do not use abrasive cloths or cleaners.***



***Do not use automatic washers or autoclaves.***



***Phenolic detergent based disinfectants, solutions containing cationic surfactants, ammonia based compounds or perfumes and antiseptic solutions such as Steriscol or Hibiscrub should never be used.***



***If detergent or disinfectant wipes are used ensure that excess solution is squeezed from the wipe prior to use.***



***Do not allow any fluid to enter the products and do not immerse in any solution.***



***Always wipe off disinfectant using a cloth dampened with clean water.***

---

## 4.2 General Cleaning and Disinfecting

Always keep the external surfaces clean and free of dirt and fluids using a clean dry cloth.

1. Wipe any fluids from the surface of the product using a clean dry cloth.
2. Wipe with a cloth dampened in 70% Isopropyl Alcohol.
3. Completely dry with a clean, dry lint free cloth.
4. If the product has been contaminated use the methods described for patient applied parts.

## 4.3 Cleaning and Disinfecting Patient Applied Parts

Clean the probes before examining a patient using low risk cleaning method below.

Following patient examination, clean and/or disinfect the probes by the appropriate method based upon the level of cross contamination risk, as defined below:

Risk	Definitions	Procedure
<b>Low</b>	Normal use or low risk situations include patients having intact skin and no known infection.	<ol style="list-style-type: none"> <li>1. Remove soiling, wipe with a mild neutral detergent and then wipe with a cloth dampened in water.</li> <li>2. Completely dry with a clean lint free cloth.</li> </ol>
<b>Medium</b>	The patient has a known infection, skin is not intact, the part is heavily soiled, or the patient has given birth in a water bath.	<ol style="list-style-type: none"> <li>1. Follow low risk procedure then wipe with a cloth dampened in Sodium Hypochlorite (1,000ppm).</li> <li>2. After two minutes wipe with a cloth dampened in water and then dry with a clean lint free cloth.</li> </ol>
<b>High</b>	This procedure should only be used when the part has been contaminated by blood.	<ol style="list-style-type: none"> <li>1. Follow low risk procedure then wipe with a cloth dampened in Sodium Hypochlorite (10,000ppm).</li> <li>2. After two minutes wipe with a cloth dampened in water and then dry with a clean lint free cloth.</li> </ol>



**Warning: Sodium Hypochlorite @ 10,000 ppm for disinfecting should only be used in situations described in the High Risk definition. Unnecessary use of this concentrated solution for Low and Medium risk situations may result in damage to the product. Do not allow Sodium Hypochlorite solutions to come into contact with metal parts.**

The use of disinfectant materials other than those listed is the responsibility of the user for their efficacy and compatibility with the device.

#### 4.4 Maintenance and Repair

There are NO USER SERVICEABLE PARTS inside the control unit or probe.

Inspection is recommended each time the product is used, paying particular attention to the tip of the probes, checking for cracks etc., and to the cable and connector. Any crackling or intermittent behaviour should be investigated.



This product does not require periodic maintenance.

Suitable test equipment and a full range of spare parts are also available. Please refer to service manual for further information and part numbers.

A full technical description is provided in the Service Manual 726374.

## 5. Specifications



### 5.1 Equipment Classification

<b>Type of protection against electric shock.</b>	Internally powered equipment
<b>Degree of protection against electric shock</b> 	Type B - equipment with an applied part. 
<b>Mode of operation.</b>	Continuous
<b>Degree of protection against harmful ingress of particles and/or water.</b>	Main Unit: Ordinary Equipment D920/D930 probes : IPX7 All other probes (Tip only): IPX1
<b>Degree of safety of application in the presence of a flammable anaesthetic</b>	Equipment not suitable for use in the presence of a FLAMMABLE ANAESTHETIC MIXTURE WITH AIR, OXYGEN OR NITROUS OXIDE

### 5.2 Standards Compliance

**IEC60601-1: 1988 + A1:1991 +A2:1995**

### 5.3 General

<b>Max. Audio Output (Loudspeaker)</b>	500mW rms typical
<b>Auto shut-off</b>	After 5 minutes continuous operation
<b>Headphones</b> 	Max. output Power: 25 mW rms (32Ω) Connector: 3.5mm stereo jack socket Max. applied voltage: +9Vdc
<b>Waveform Output (D900 only)</b> 	Zero crosser, 0.5V/kHz, 3.5V full scale Cal levels: 1kHz + 2kHz, (max. applied voltage +9Vdc) 3.5mm mono socket
<b>Battery Type</b>	IEC 6LR61 or IEC 6LP3146
<b>Battery Life</b>	Typically, 500 x 1 minute examinations
<b>Size</b>	Height 5.5", Depth 1.1", Width 2.9"
<b>Weight</b>	10oz including probe and battery

### 5.4 Environmental

<b>Operating</b>		<b>Storage</b>
+50°F to +86°F (+10°C to +30°C)	<b>Temperature range</b>	+14°F to +104°F (-10°C to +40°C)
10% to 90% (non condensing)	<b>Relative Humidity</b>	93% maximum
860mb to 1060mb	<b>Pressure</b>	860mb to 1060mb

## 6. End of Life Disposal

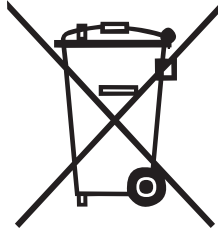

This symbol signifies that this product, including its accessories and consumables is subject to the WEEE (Waste Electrical and Electronic Equipment) regulations and should be disposed of responsibly in accordance with local procedures.

## 7. Warranty

a) ARJOHUNTLEIGH INC. HEREBY DISCLAIMS ALL EXPRESS OR IMPLIED WARRANTIES (INCLUDING BUT NOT LIMITED TO WARRANTIES OF MERCHANTABILITY OR FITNESS FOR A PARTICULAR PURPOSE) AND ANY AGREEMENTS, REPRESENTATIONS, AFFIRMATIONS, OR WARRANTIES, WHETHER ORAL OR WRITTEN, MADE BY ANY AGENT, EMPLOYEE OR REPRESENTATIVE OF ARJOHUNTLEIGH INC., UNLESS SPECIFICALLY SET FORTH IN THIS PARAGRAPH. ARJOHUNTLEIGH INC. SHALL NOT BE LIABLE FOR BREACH OF CONTRACT ARISING FROM ANY DEFECT IN MATERIAL OR WORKMANSHIP OF THE GOODS. ALL LEGISLATION RELATING TO EXPRESS AND IMPLIED WARRANTIES OR OTHER OBLIGATIONS ON THE PART OF ARJOHUNTLEIGH INC. THAT MAY BE LAWFULLY EXCLUDED ARE HEREBY EXCLUDED.

b) Notwithstanding the foregoing, ArjoHuntleigh Inc.'s sole warranty is that the Goods shall be free from defects in material and workmanship for a period of three (3) years (excluding probe head and retractile cable which are warranted for one (1) year, following delivery of such Goods to the original purchaser; provided that the Goods were used in an appropriate and reasonable manner during such period and provided further that ArjoHuntleigh Inc. shall be in no event be liable to Customer for defective Goods if: (i) the Goods are damaged in the course of shipping; (ii) any defect is caused wholly or to any material extent by customer's negligence, misuse, failure to use the Goods properly or use of the Goods in conjunction with any accessory not approved for use with the Goods by ArjoHuntleigh Inc.; (iii) the Goods are damaged as a result of improper maintenance, failure to follow manufacturer's instructions, including without limitation those on washing and cleaning, or failure to follow necessary routine maintenance procedures; or (iv) the Goods are altered, repaired or dismantled other than with manufacturer's written authorization using its approved procedures or by any party other than manufacturer's properly qualified and trained technicians.

c) Customer must provide written notice to ArjoHuntleigh Inc., within said warranty period of any defect in the Goods. Upon ArjoHuntleigh Inc.'s written request, Customer must return such Goods adequately packed (in their original packing) and fully insured to ArjoHuntleigh Inc.'s place of business and shall be responsible for all shipping costs incurred therein. Customer's exclusive remedy and ArjoHuntleigh Inc.'s exclusive liability for any claim for loss, damage or destruction resulting from any defects in materials and workmanship shall be limited to repair, service, adjustment or replacement (at ArjoHuntleigh Inc.'s option) of any nonconforming or defective Goods. ArjoHuntleigh Inc. will have a reasonable time to repair, service or replace such Goods. Any Goods returned to ArjoHuntleigh Inc. which are found not to be defective in breach of the warranty in Subsection (b) above, shall be returned to the Customer in the manner described in this subsection.

d) IN NO EVENT SHALL ARJOHUNTLEIGH INC. BE LIABLE FOR ANY INCIDENTAL OR CONSEQUENTIAL LOSSES OR DAMAGES (INCLUDING BUT NOT LIMITED TO ECONOMIC LOSS, LOSS OF PROFITS OR SPECIAL DAMAGES) ARISING OUT OF OR INCURRED BY CUSTOMER IN CONNECTION WITH THE PURCHASE OF ARJOHUNTLEIGH INC.'S GOODS EVEN IF ARJOHUNTLEIGH INC. HAS BEEN ADVISED OR HAS KNOWLEDGE OF THE POSSIBILITY OR EXTENT OF SUCH DAMAGES SUFFERED OR INCURRED BY CUSTOMER OR ANY END USER AS A RESULT OF OR IN CONNECTION WITH ANY BREACH OF THESE TERMS AND CONDITIONS BY ARJOHUNTLEIGH INC. OR ANY TORT (INCLUDING BUT NOT LIMITED TO STRICT LIABILITY OR NEGLIGENCE) COMMITTED BY ARJOHUNTLEIGH INC., ITS AGENTS OR REPRESENTATIVES IN CONNECTION WITH THESE TERMS AND CONDITIONS OR ANY CONTRACT WITH CUSTOMER FOR THE SUPPLY OF GOODS.

e) Customer shall not create, directly or indirectly, any warranty obligations on the part of ArjoHuntleigh Inc. to the customers of Customer, and in particular, without limiting the foregoing, Customer agrees not to pass on to its customers any warranties beyond or in addition to those given by ArjoHuntleigh Inc. to Customer hereunder. Where the Customer is a dealer in the Goods, it shall be responsible for the labor cost of all repairs and ArjoHuntleigh Inc. shall be responsible for providing all repair parts during said three (3) year (excluding probe head and retractile cable which are warranted for one (1) year). The dealer shall provide written verification of warranty repairs including the original invoice number, date of purchase, description of repairs, name of its customer and date of sale to such customer.

f) Customer shall be deemed to have full knowledge of the nature and properties of the Goods ordered and of any hazards they involve and the proper treatment, storage and handling thereof. Any technical advice furnished by ArjoHuntleigh Inc. or its representatives or agents is given only on the basis that it is followed at the Customer's own risk.

## 8. Service

### Service Returns

If for any reason Dopplex unit has to be returned, please:

- Clean the product following the instructions in this manual.
- Pack it in suitable packing.
- Attach a decontamination certificate (or other statement declaring that the product has been cleaned) to the outside of the package.
- Call Huntleigh in Addison, IL for a return authorization number.

Huntleigh Healthcare Ltd reserve the right to return product that does not contain a decontamination certificate.

For service, maintenance and any questions regarding this, or any other Huntleigh Healthcare Dopplex product, please contact:

Service Department  
ArjoHuntleigh Inc.  
2349 West Lake Street,  
Addison,  
IL 60101, USA

T: 1-800-323-1245 option 2

W: [www.ArjoHuntleigh.com](http://www.ArjoHuntleigh.com)

**© Huntleigh Healthcare Ltd**  
**All rights reserved**



The Dopplex doppler is in conformity with the Medical Devices Directive 93/42/EEC as amended by 2007/47/EC and has been subject to the conformity assurance procedures laid down by the Council Directive

**Manufactured in the UK by Huntleigh Healthcare Ltd.**  
**As part of the ongoing development programme the company reserves the right to modify specifications and materials without notice.**

**Dopplex, and Huntleigh are registered trademarks of Huntleigh Technology Ltd.**  
**2004.**

**© Huntleigh Healthcare Ltd. 2004-2014**

# HUNTLEIGH *...performance for life*

Huntleigh Healthcare Ltd. - Diagnostic Products Division

35 Portmanmoor Road, Cardiff, CF24 5HN, United Kingdom

T: +44 (0)29 20485885 F: +44 (0)29 20492520

E: [sales@huntleigh-diagnostics.co.uk](mailto:sales@huntleigh-diagnostics.co.uk)

W: [www.huntleigh-diagnostics.com](http://www.huntleigh-diagnostics.com)

DISTRIBUTED IN THE USA BY:

ArjoHuntleigh Inc.

2349 West Lake Street, Addison, IL 60101, USA

T: 800-223-1218

W: [www.ArjoHuntleigh.com](http://www.ArjoHuntleigh.com)



Registered No: 942245 England & Wales. Registered Office: ArjoHuntleigh House, Houghton Hall Business Park, Houghton Regis, Bedfordshire, LU5 5XF

© Huntleigh Healthcare Limited 2004-2014

AN **ARJO**HUNTLEIGH COMPANY, MEMBER OF THE GETINGE GROUP

® and ™ are trademarks of Huntleigh Technology Limited

As our policy is one of continuous improvement, we reserve the right to modify designs without prior notice.

734321-US-4  
(ENGLISH)